







JOLLY SLIM 32 - 1...10 V & PUSH

TCI LED

Direct current dimmable electronic drivers with DIP-SWITCH
Alimentatori elettronici regolabili in corrente continua con DIP-SWITCH

Made in Europe 

1...10 V PUSH constant CURRENT constant VOLTAGE

UL-CLASS2 CSA-LVLE       **SELV**

RIPPLE FREE



ACTIVE PFC  DIP-SWITCH  1-2kV DIFF. 2kV COMM.  SYNC.  SAFETY PROTECTIONS 

Rated Voltage
Tensione Nominale

110 ÷ 120 V⁽²⁾
220 ÷ 240 V

Frequency
Frequenza

50...60 Hz

AC Operation range
Tensione di utilizzo AC

99 ÷ 264 V

DC Operation range
Tensione di utilizzo DC

DC 176 ÷ 280 V

(NO PUSH mode function)

Power
Potenza

0 ÷ 32 W

Maximum current output ripple
Max. ondulazione della corrente uscita
≤ 3%⁽¹⁾

Reference Norms
Norme di riferimento:

CSA 22.2 no. 250.13
EN 50172 (VDE 0108)
EN 55015
EN 61000-3-2
EN 61000-3-3
EN 61347-1
EN 61347-2-13
EN 61547
EN 62384
UL 1310
UL 8750
VDE 0710-T14

Article Articolo	Code Codice	P out W	V out DC	I out DC	n° LED max. ⁽¹⁾	V out max.	ta °C	tc °C	λ max. Power Factor	η max. Efficiency ⁽¹⁾	
DC JOLLY SLIM	122680	Constant current output - Uscita in corrente costante					53	-25...+50	85	0,96	>87
		17 (15 ⁽²⁾)	47 max.	350 mA cost.	12						
		24 (15 ⁽²⁾)	47 max.	500 mA cost.	12						
		32 (15 ⁽²⁾)	47 max.	700 mA cost.	12						
		Constant voltage output - Uscita in tensione costante									
		20 (15 ⁽²⁾)	24 cost.	900 mA max.	-	-					

⁽¹⁾ Referred to V_{in} = 230 V, 100% load - Riferito a V_{in} = 230 V, carico 100%

Accessories not supplied - Accessori non a corredo		
Article - Articolo	L (length)	Code - Codice
Synchronization cable Cavetto di sincronizzazione	1,5 m / 4 ft	485720512
	4 m / 13 ft	485720513
	50 cm / 19,68"	485720515
	20 cm / 7,87"	485720516
IP67 protection cover Cover di protezione IP67		180066/390
REG 1-10 V (pag. 351)		123999L
DCC DALI INTERFACE (pag. 328)		122099
BMU DMX INTERFACE (pag. 330)		122066

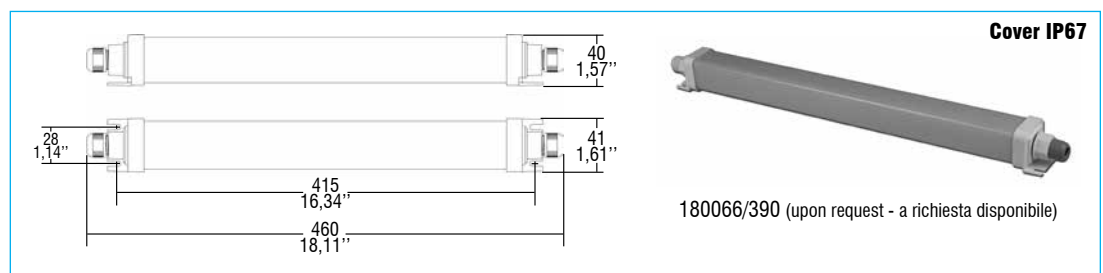

Features

- Multipower driver supplied with dip-switch for the selection of the output current.
- Driver for built-in use.
- It can be used for lighting equipment in protection class I.
- Active Power Factor Corrector.
- Current regulation ± 5 % including temperature variations.
- Input and output terminal blocks on the opposite sides (wire cross-section up to 1,5 mm² / AWG15).
- IP67 cover available upon request (code 180066/390).
- Protections:
 - against overheating and short circuits;
 - against mains voltage spikes;
 - against overloads.

Caratteristiche

- Alimentatore multipotenza fornito di dip-switch per la selezione della corrente in uscita.
- Alimentatore da incorporare.
- Utilizzabile per apparecchi di illuminazione in classe di protezione I.
- PFC attivo.
- Corrente regolata ± 5 % incluse variazioni di temperatura.
- Morsetti di entrata e uscita contrapposti (sezione cavo fino a 1,5 mm² / AWG15).
- A richiesta disponibile versione con cover di protezione IP67 (codice 180066/390).
- Protezioni:
 - termica e cortocircuito;
 - contro le extra-tensioni di rete;
 - contro i sovraccarichi.

7 YEARS WARRANTY
3% FAILURE RATE

10 YEARS WARRANTY
5% FAILURE RATE



Weight - Peso gr. 110 / 3,88 oz.
 Pcs - Pezzi 50

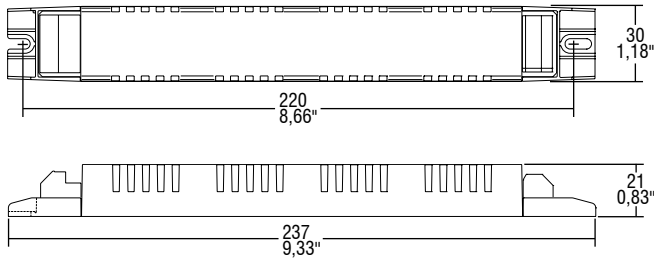

Wiring diagram - Schema di collegamento (Max. LED distance on page info8 - Massima distanza LED a pagina info8)

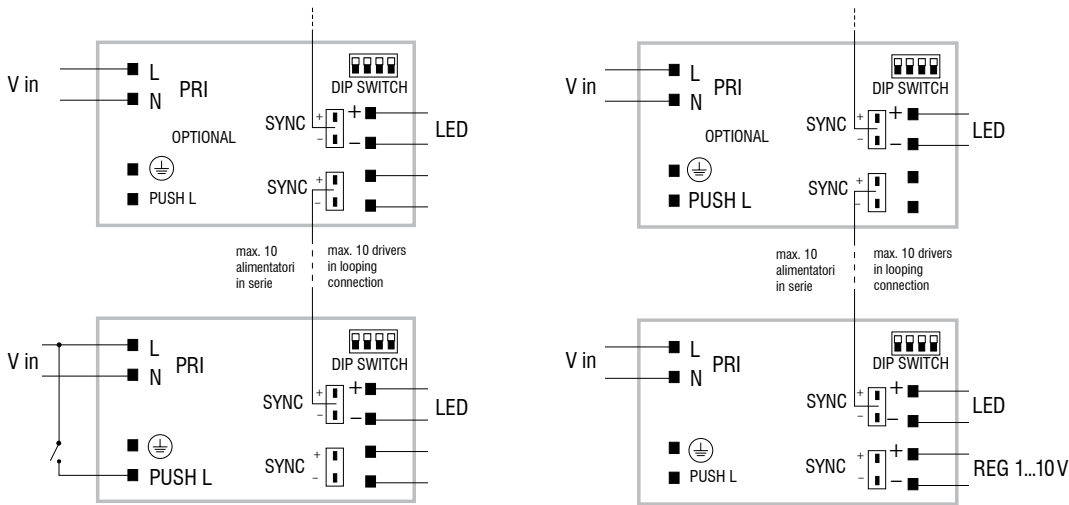

PUSH diagram - Collegamento PUSH

1...10 V diagram - Collegamento 1...10 V

Operation Mode

- Light regulation 0/0,5 - 100 % by means of PUSH function, 1...10 V interface (I = 0,35 mA) or 100 Kohm potentiometer.
- Light regulation 0/0,5 - 100 % by means of PUSH function (L mains voltage; 170 Kohm):
 - a short push to turn on and off;
 - a longer push to increase or decrease light intensity;
 - regulation automatically stops at minimum and maximum values;
 - for another on, regulation or off command, release the push button and give the desired command again.
- Maximum length of the cable, from push button to last driver, must be max. 15 m / 49 ft. In case of applications where the cable is longer than 15 m / 49 ft, keep this separate from the 110 - 240 Volt mains cable.
- ATTENTION: only use normally open push buttons with no incorporated warning light.
- Specific dimming terminal connection with a 1...10 Vdc electronic potentiometer (1...10 V local dimming, double insulation required for external connection).
- Max. 10 synchronised drivers of which only one can be controlled (1 Master + 9 Slaves).
- Synchronization cable is separately supplied.

For additional details for regulations see pages info12-14.

Modalità di funzionamento

- Regolazione della luminosità 0/0,5 - 100 % mediante funzione PUSH, interfaccia 1...10 V (I = 0,35 mA) o potenziometro da 100 Kohm.
- Regolazione della luminosità 0/0,5 - 100 % mediante la funzione PUSH (tensione di rete L; 170 Kohm):
 - una pressione breve per accendere e spegnere;
 - una pressione prolungata per aumentare o diminuire l'intensità luminosa;
 - la regolazione si ferma automaticamente ai valori minimi e massimi;
 - per un nuovo comando accensione, regolazione o spegnimento, rilasciare il pulsante e dare nuovamente il comando desiderato.
- La lunghezza massima del cavo, dal pulsante all'ultimo trasformatore, deve essere max. 15 m / 49 ft. In caso di applicazioni dove il cavo superi i 15 m / 49 ft, tenere lo stesso separato dal cavo di rete 110 - 240 Volt.
- ATTENZIONE: usare solo pulsanti di tipo normalmente aperto privi di spia luminosa incorporata.
- Provvisto di morsetto specifico per la regolazione collegando un potenziometro elettronico 1...10 Vdc (dimmerazione locale 1...10 V, per connessioni esterne all'apparecchio garantire il doppio isolamento)
- Max. 10 alimentatori sincronizzati, di cui uno solo comandato da uno o più punti (1 Master + 9 Slaves).
- Cavetto per la sincronizzazione fornito separatamente.

Per ulteriori dettagli sulle regolazioni vedi pagine info12-14.